

# ROSS GARDAM



The Tailored range is a modular collection of upholstered products for office and open spaces.

Designed with the desire to facilitate communication between people while also providing a space for quiet work and reflection.

The upholstery details of the Tailored Collection is inspired by the stitching detail of fine suiting. The collection features a total of 30 elegant seating configurations, with custom lengths available, offering flexible workspace solutions for any project.



Tailored has a contemporary yet classic form with a signature fine stitch detail, seamlessly fitting into any workplace.



## 01 DETAILS

The solid oak leg with its geometric form is a shared characteristic of the Tailored collection, providing a strong visual connection between the lounges and coffee tables.





#### 02 DETAILS

A highly refined level of craftsmanship is displayed in the stitch and seam details of the Tailored collection.

## 03 DETAILS

The Tailored Lounge is available in a low-back and a high-back version. Both are available in a plethora of standard configurations with custom sizes available on request.



# EXAMPLE CONFIGURATIONS <sup>01</sup>

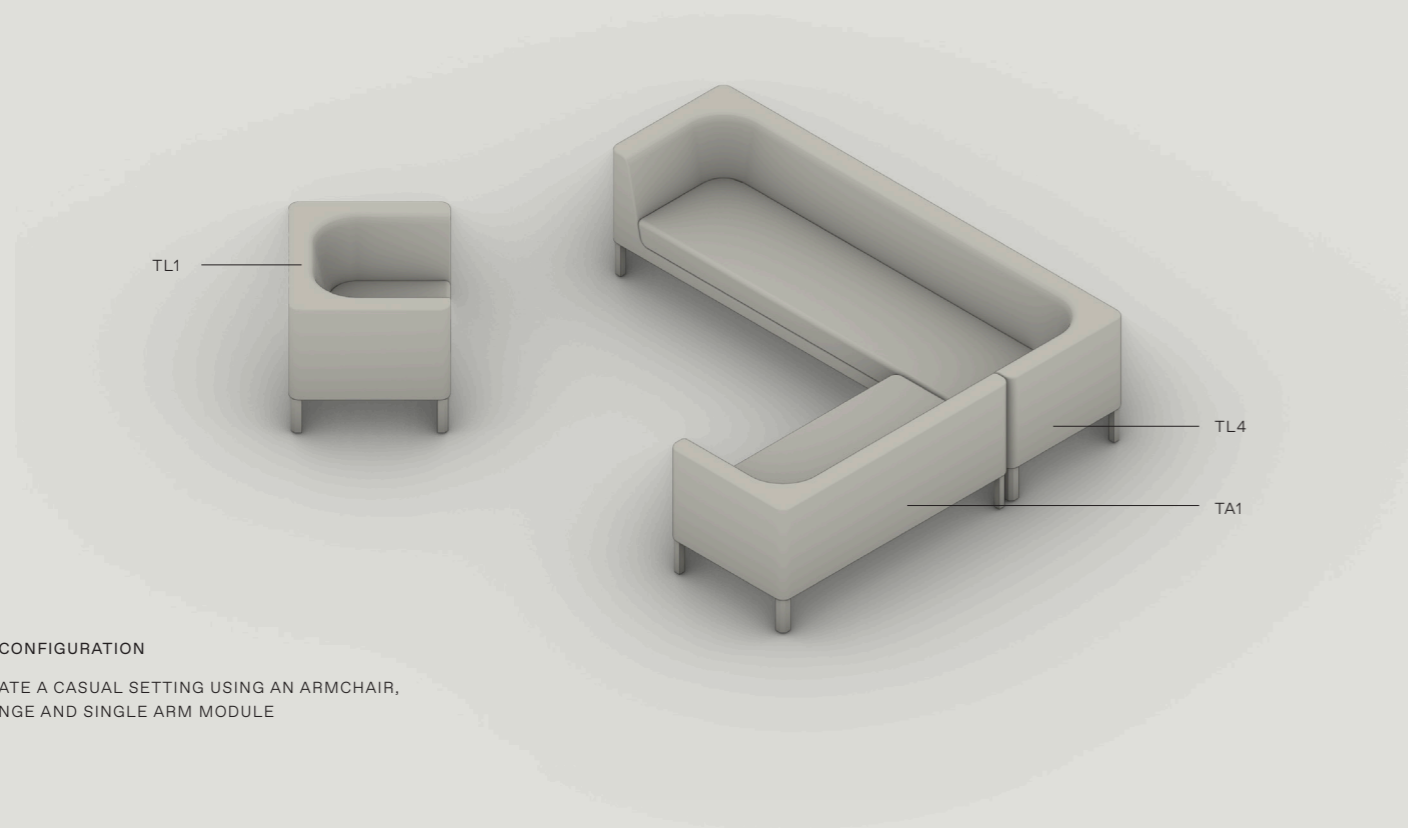

01 / CONFIGURATION

CREATE A CASUAL SETTING USING AN ARMCHAIR, LOUNGE AND SINGLE ARM MODULE

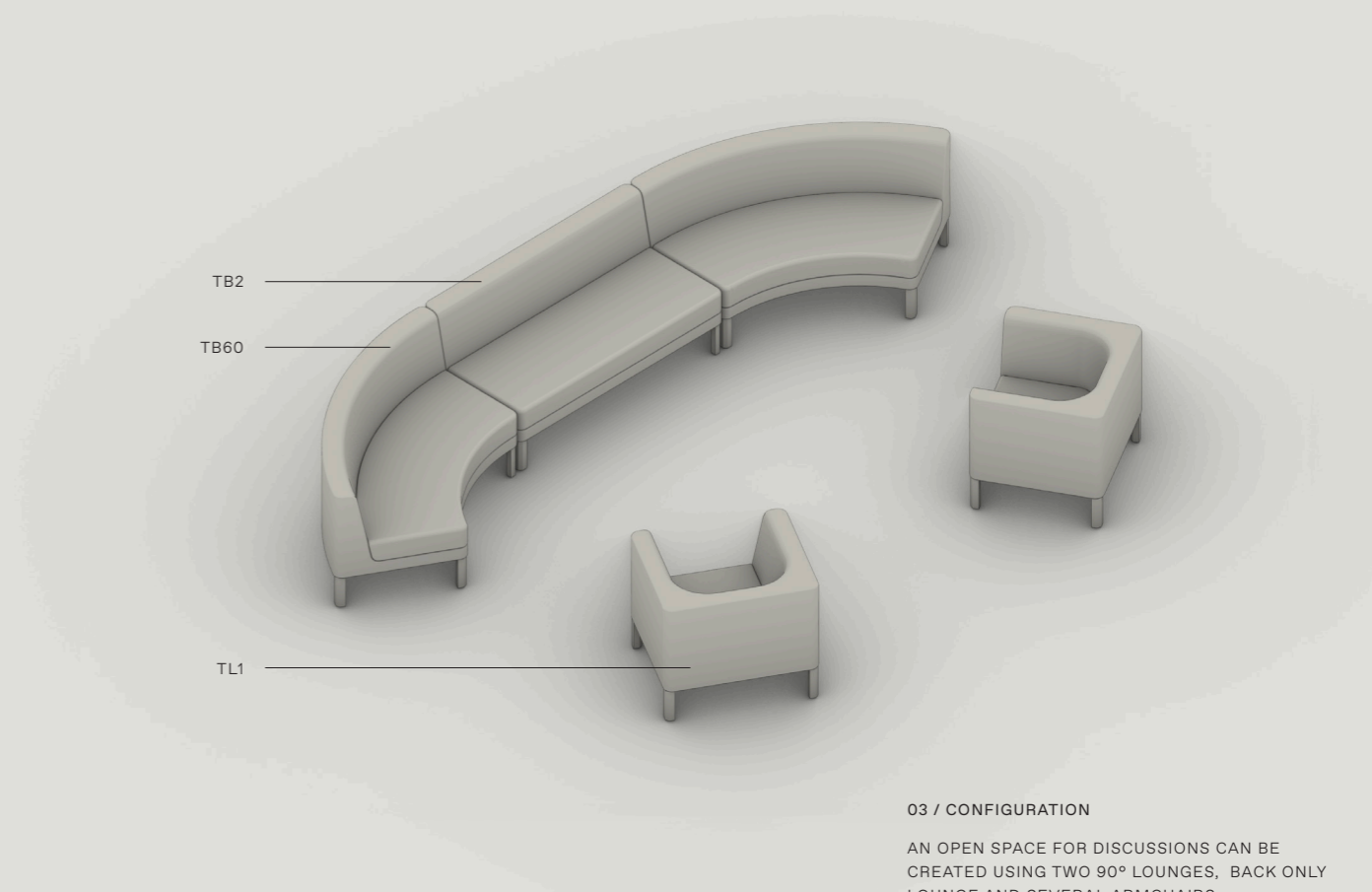

03 / CONFIGURATION

AN OPEN SPACE FOR DISCUSSIONS CAN BE CREATED USING TWO 90° LOUNGES, BACK ONLY LOUNGE AND SEVERAL ARMCHAIRS

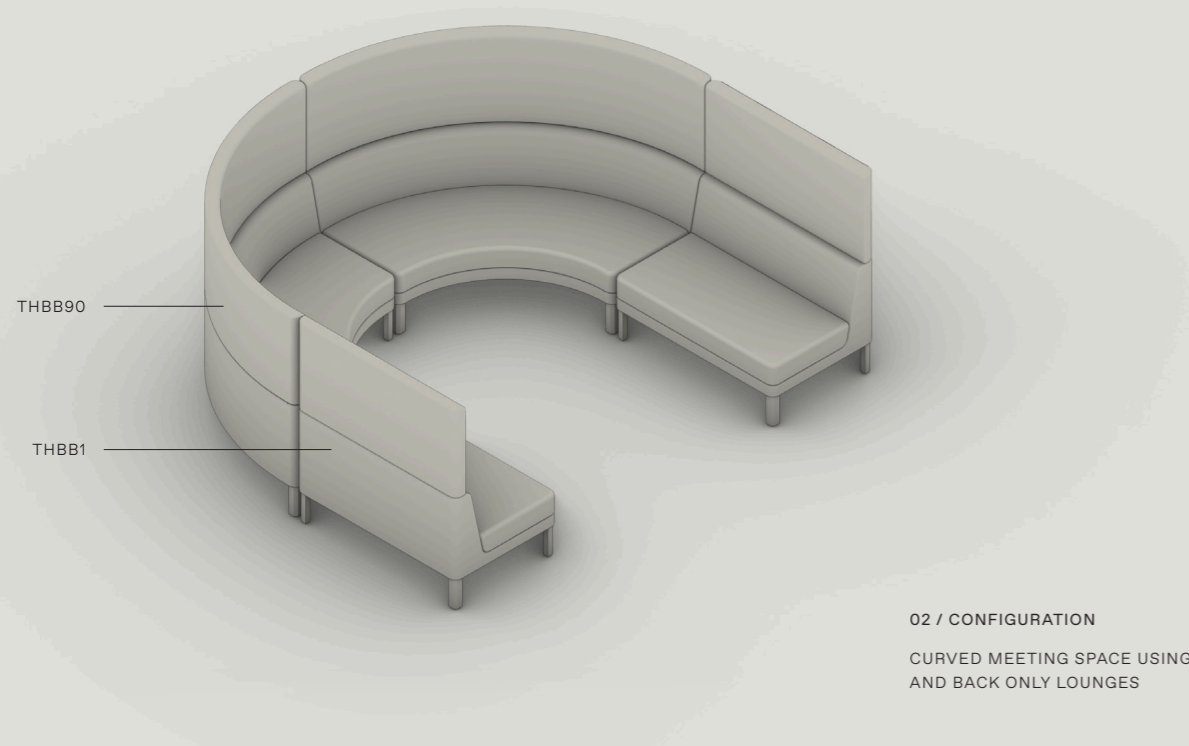

02 / CONFIGURATION

CURVED MEETING SPACE USING TWO 90° LOUNGES AND BACK ONLY LOUNGES

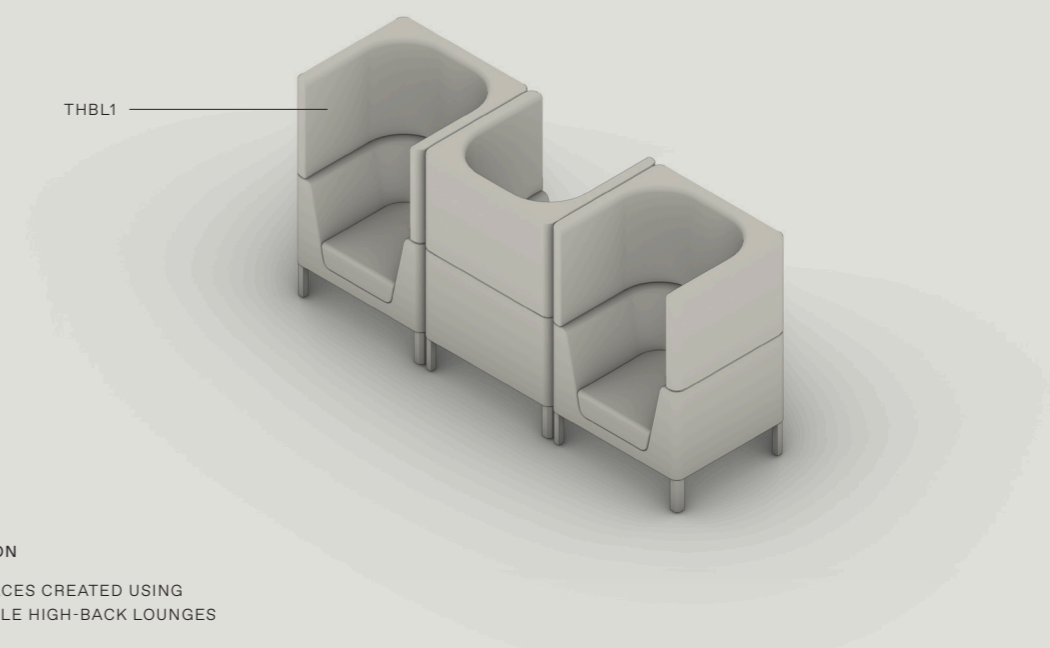

04 / CONFIGURATION

PRIVATE WORK SPACES CREATED USING ALTERNATING SINGLE HIGH-BACK LOUNGES

05 / CONFIGURATION

LARGER 60 DEGREE LOUNGES PROVIDE MORE SPACIOUS MEETING SPACES, WITH THE ADDITION OF UNIVERSAL TABLES ENABLING MOVABLE WORK SURFACES

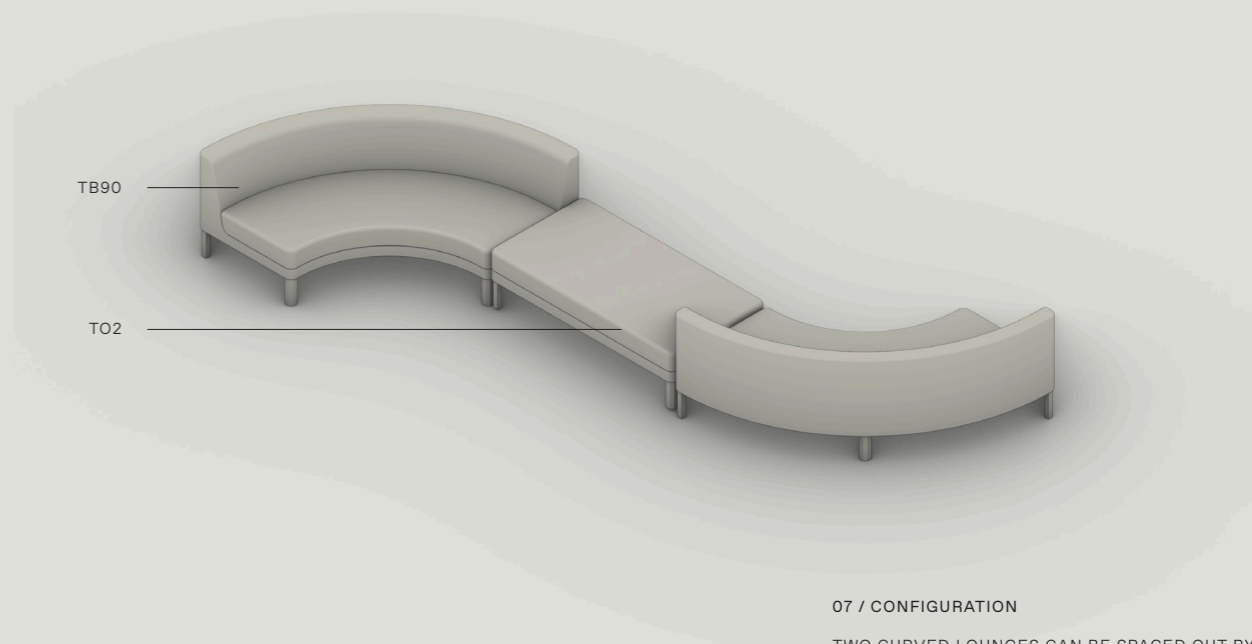
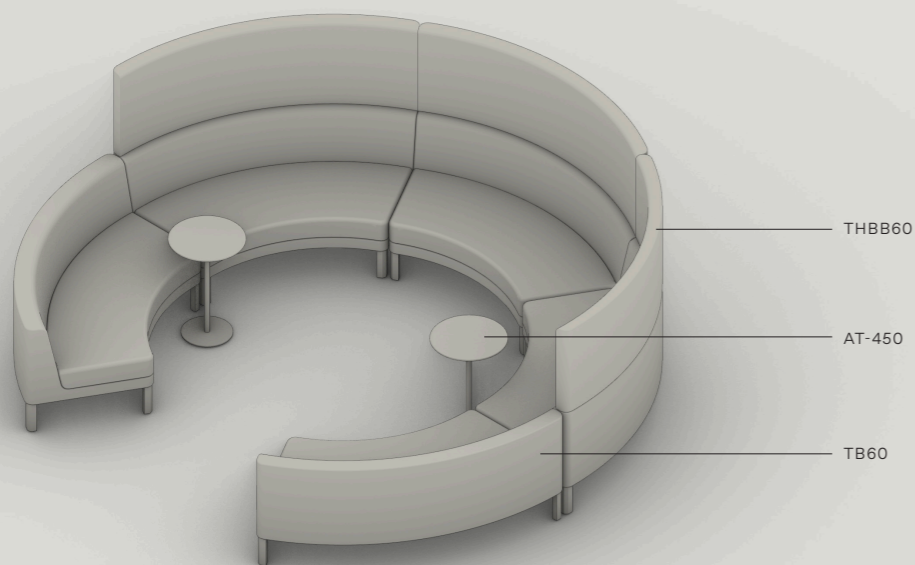

07 / CONFIGURATION

TWO CURVED LOUNGES CAN BE SPACED OUT BY PLACING AN OTTOMAN IN BETWEEN CREATING MULTI-SIDED SEATING

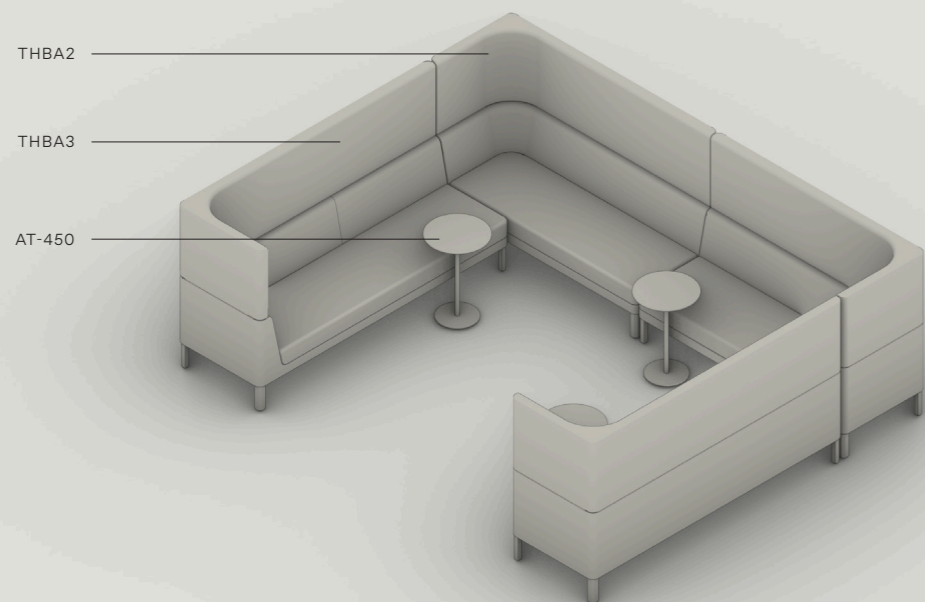

06 / CONFIGURATION

HIGH-BACK SINGLE ARM LOUNGES CAN BE USED TO FORM A SQUARE SEATING CONFIGURATION TO CREATE A PRIVATE SPACE

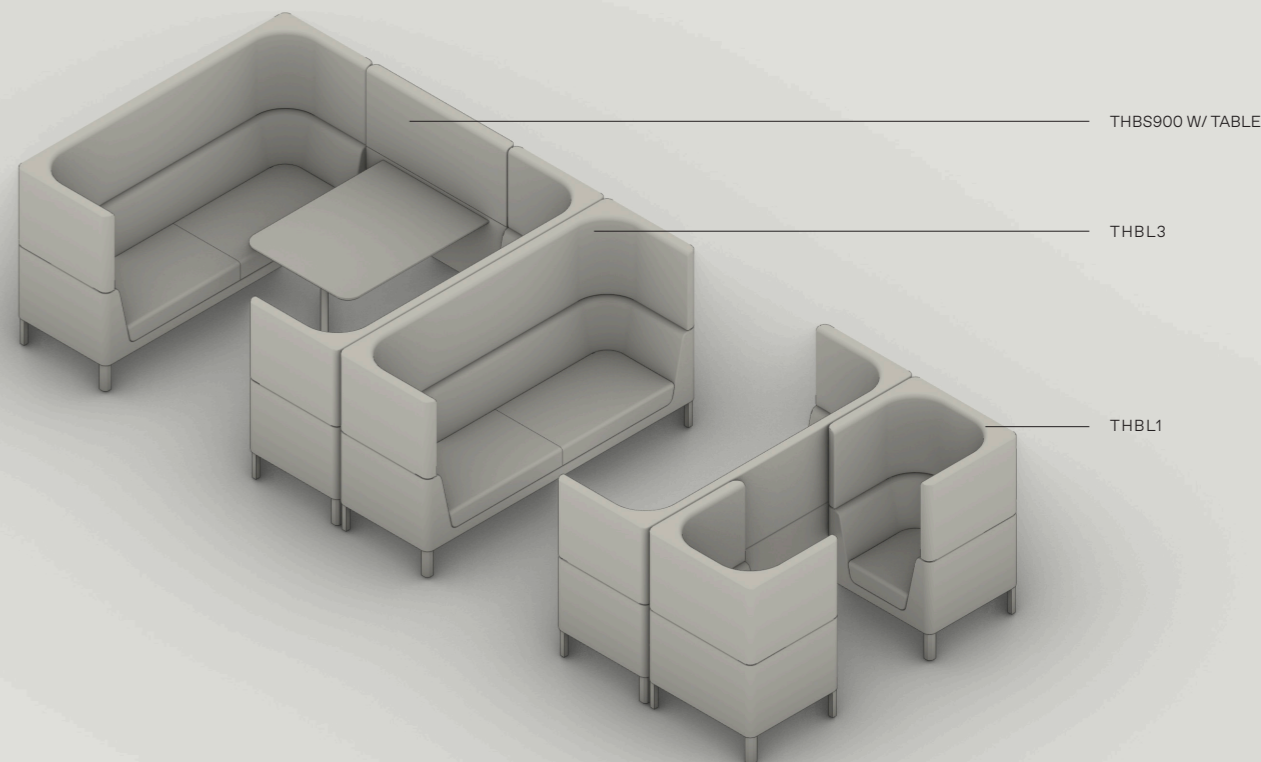

08 / CONFIGURATION

A ROW OF HIGH-BACK LOUNGES, ARMCHAIRS AND A BOOTH SCREEN WITH A TABLE CREATES SEPARATE BREAKOUT AREAS FOR PRIVATE CONVERSATIONS AND MEETINGS

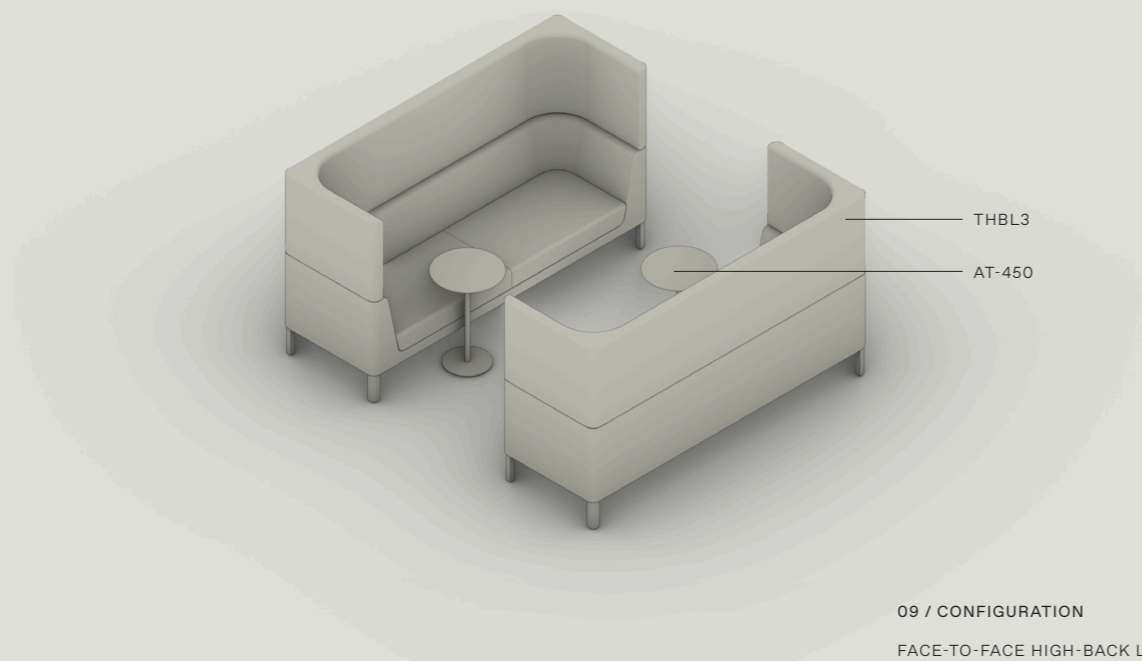

09 / CONFIGURATION  
FACE-TO-FACE HIGH-BACK LOUNGES CREATE A CLOSE SPACE FOR MEETINGS AND WORK

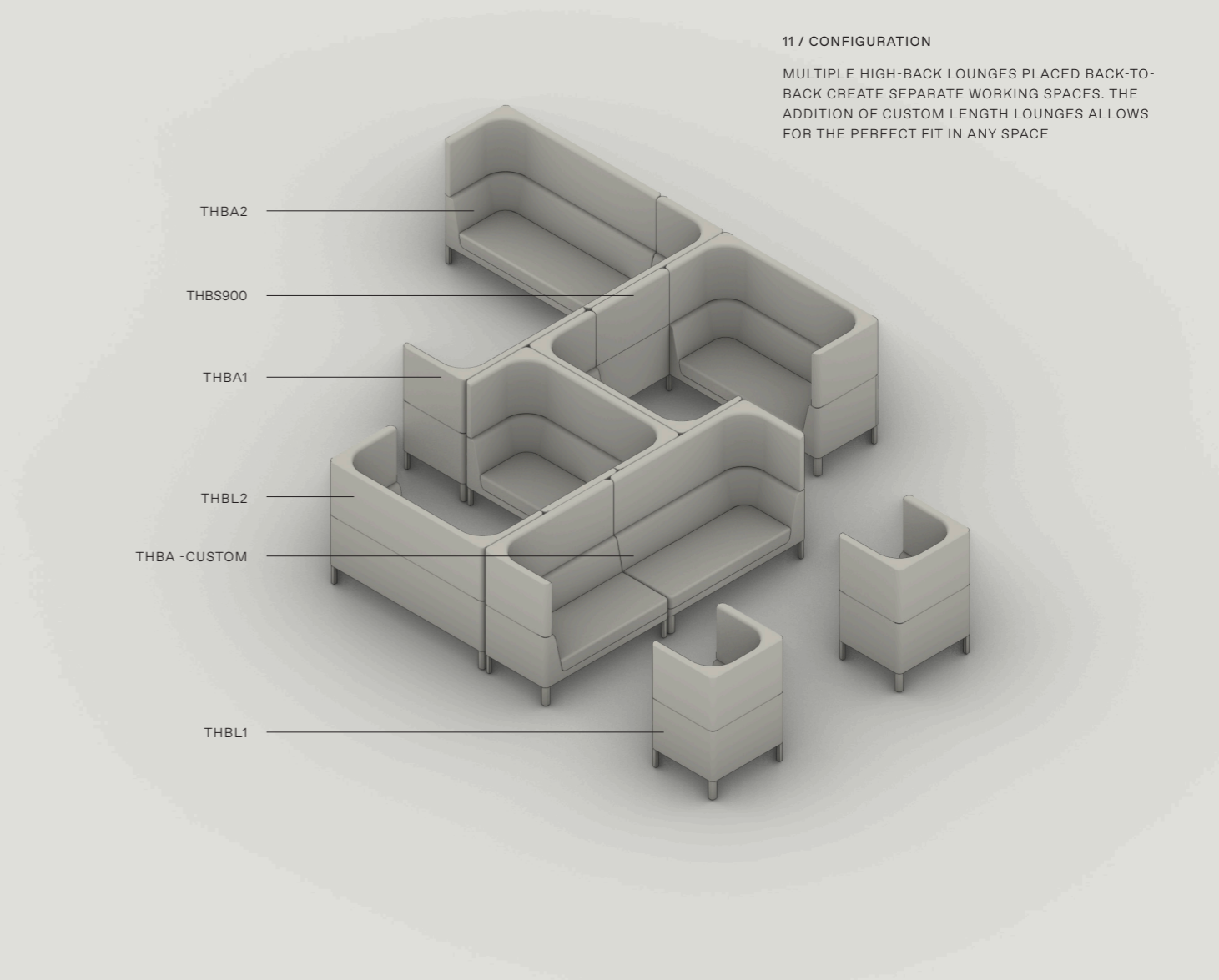

11 / CONFIGURATION  
MULTIPLE HIGH-BACK LOUNGES PLACED BACK-TO-BACK CREATE SEPARATE WORKING SPACES. THE ADDITION OF CUSTOM LENGTH LOUNGES ALLOWS FOR THE PERFECT FIT IN ANY SPACE

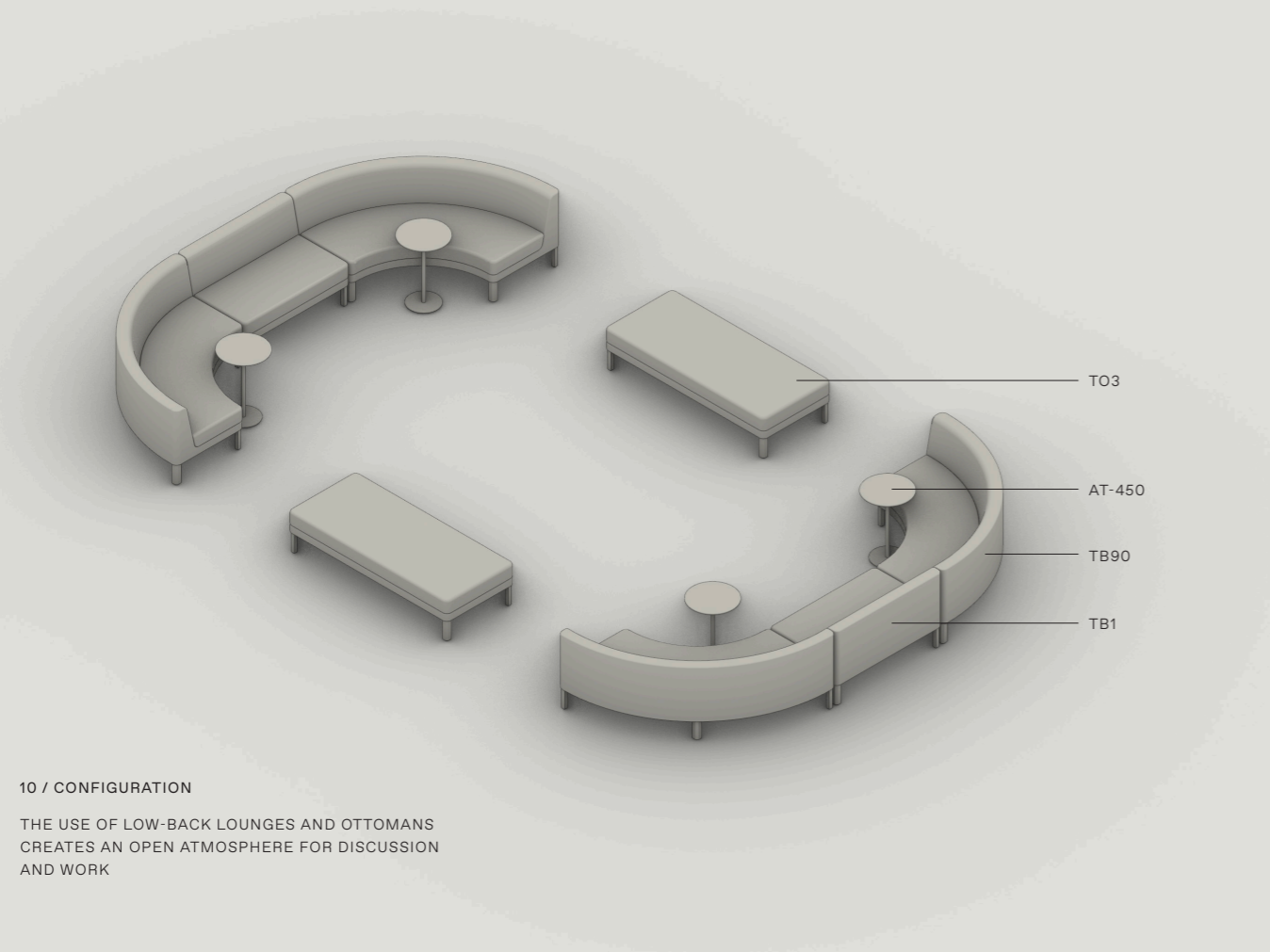

10 / CONFIGURATION  
THE USE OF LOW-BACK LOUNGES AND OTTOMANS CREATES AN OPEN ATMOSPHERE FOR DISCUSSION AND WORK

12 / CONFIGURATION  
90° CURVED UNITS CAN BE SPACED APART TO CREATE AN OPEN SEATING ARRANGEMENT

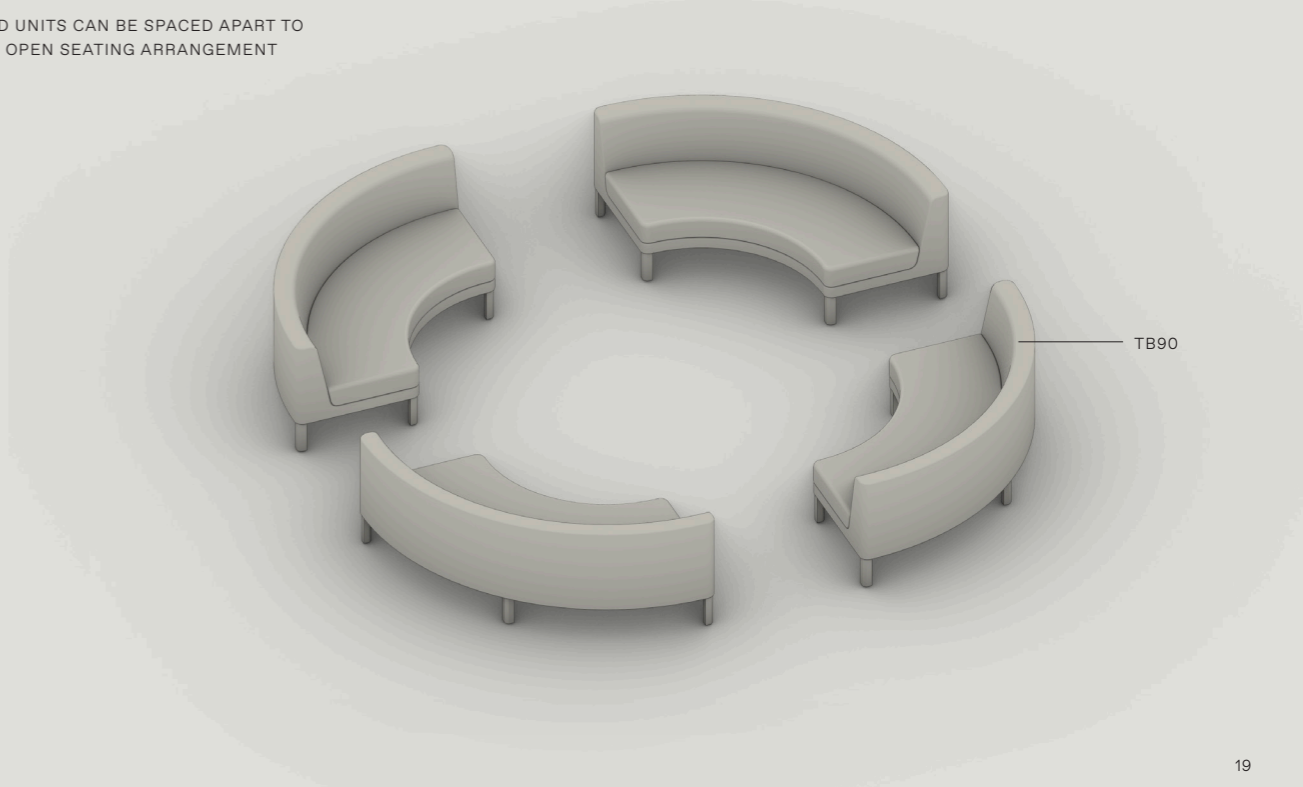

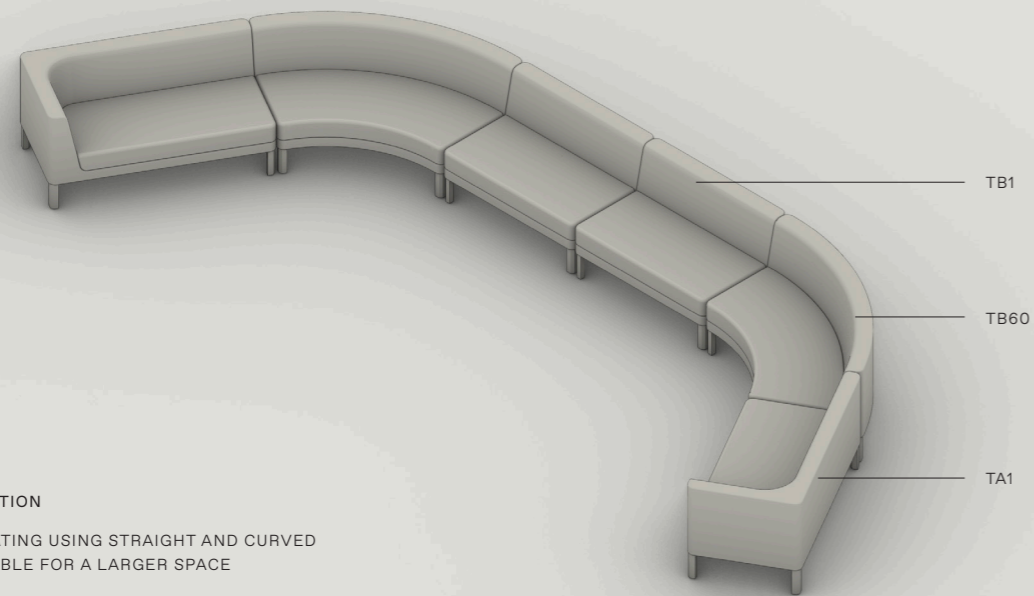

13 / CONFIGURATION

OPEN PLAN SEATING USING STRAIGHT AND CURVED LOUNGES SUITABLE FOR A LARGER SPACE

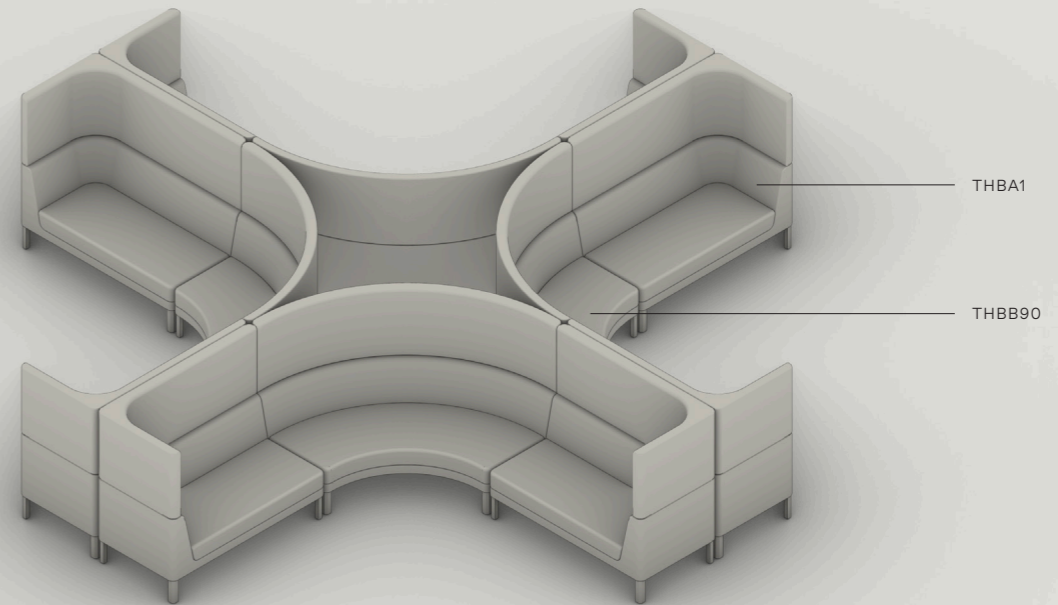

15 / CONFIGURATION

REVERSE CURVED MODULES CAN BE USED TO DESIGN SEATING AROUND OBJECTS SUCH AS COLUMNS AND PLANTERS

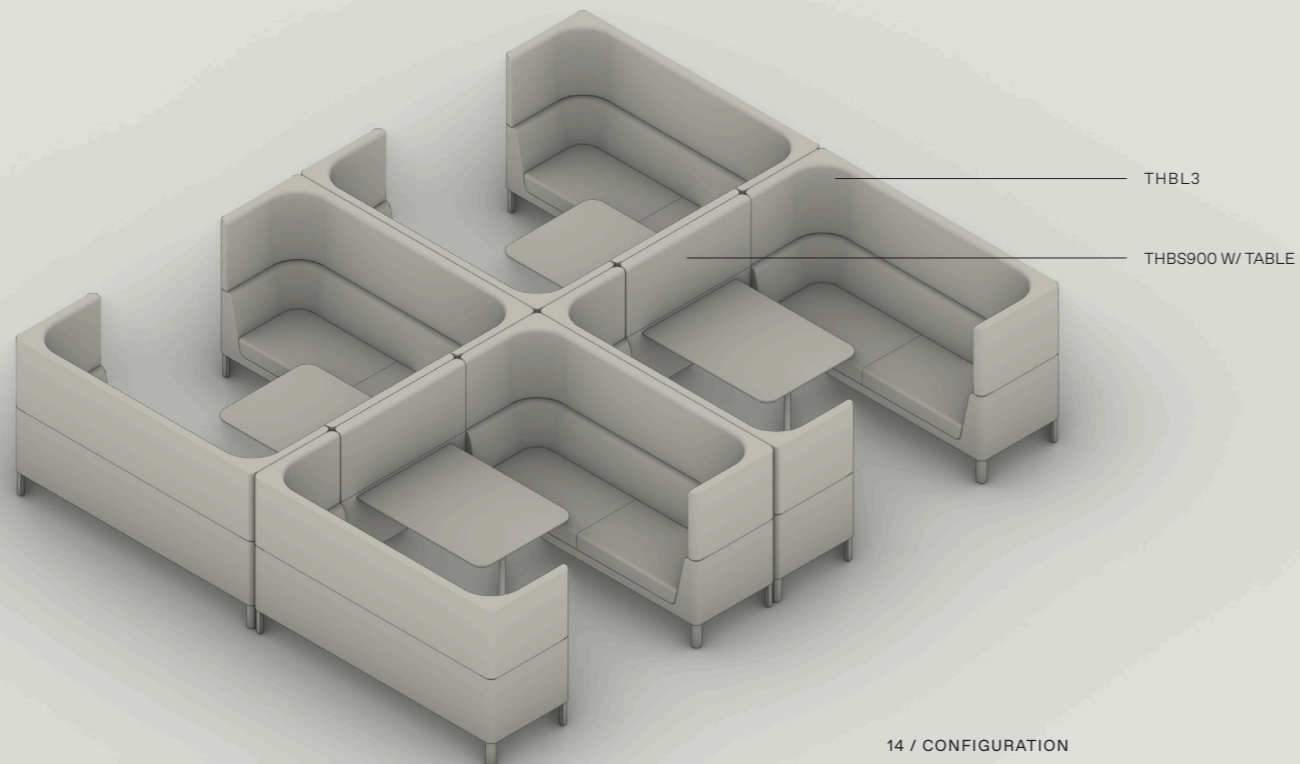

14 / CONFIGURATION

A BANK OF BOOTHS WITH TABLES ALLOWS FOR MULTIPLE PRIVATE MEETING SPACES

16 / CONFIGURATION

THE ADDITION OF MOVABLE UNIVERSAL TABLES PROVIDES WORKSPACES FOR NOTE TAKING AND LAPTOP USE

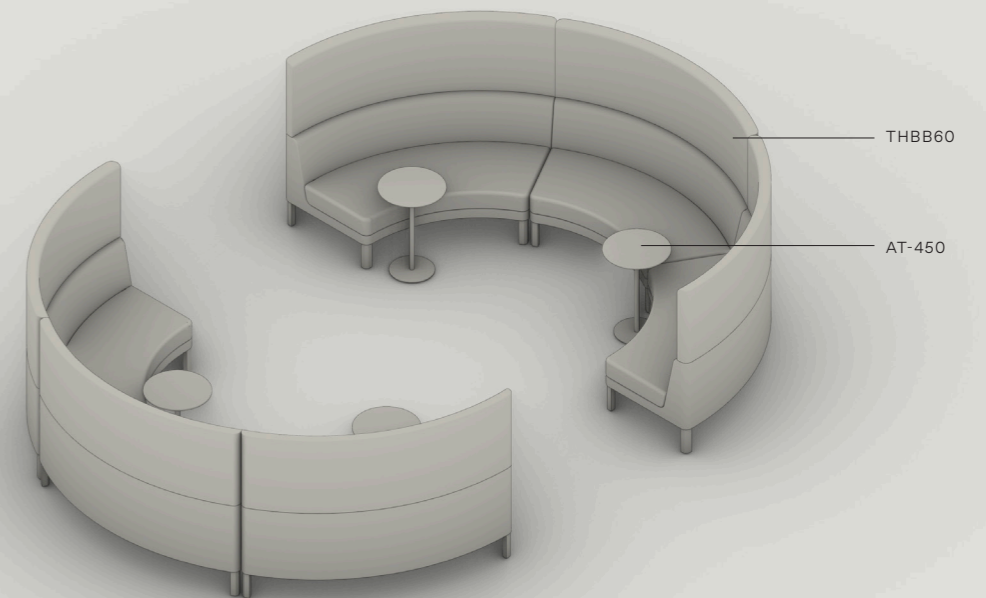

## POWER <sup>02</sup>

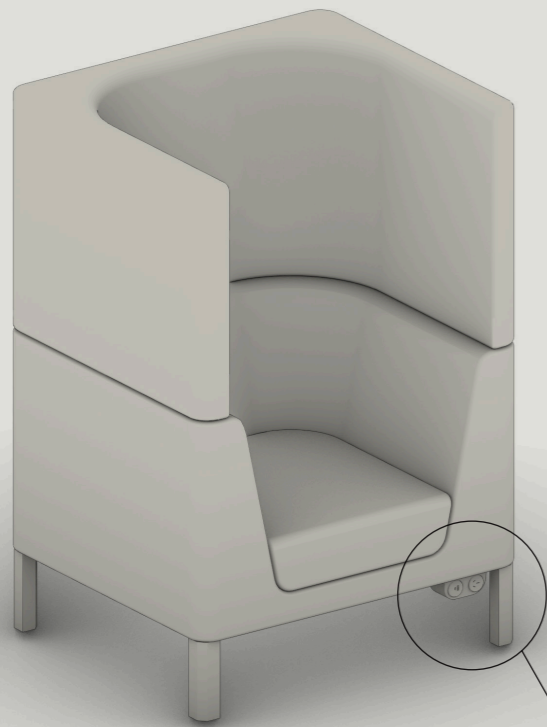

### 01 / POWER

POWER AND USB CHARGING AVAILABLE IN LOCATIONS ALONG THE UNDERSIDE OF THE FRONT AND SIDE OF EACH LOUNGE VARIATION. AVAILABLE IN MULTIPLE COLOURS, USB FAST-CHARGE AND AS/NZS OR INTERNATIONAL SOCKETS.

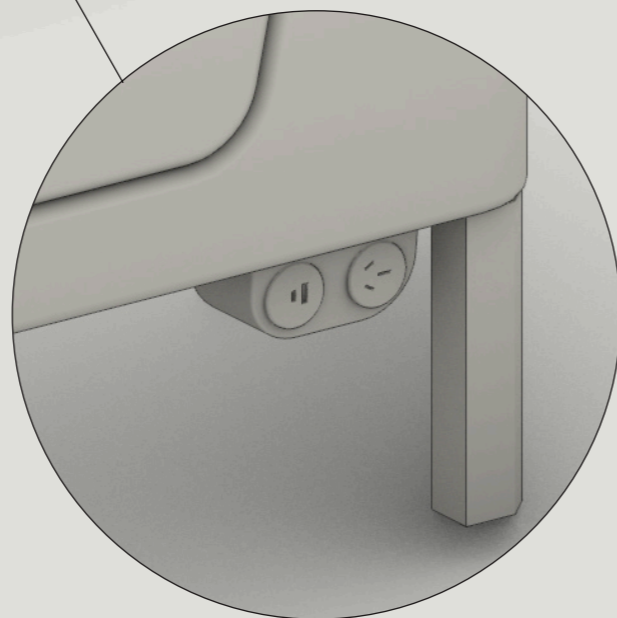

## WORK TABLE <sup>03</sup>

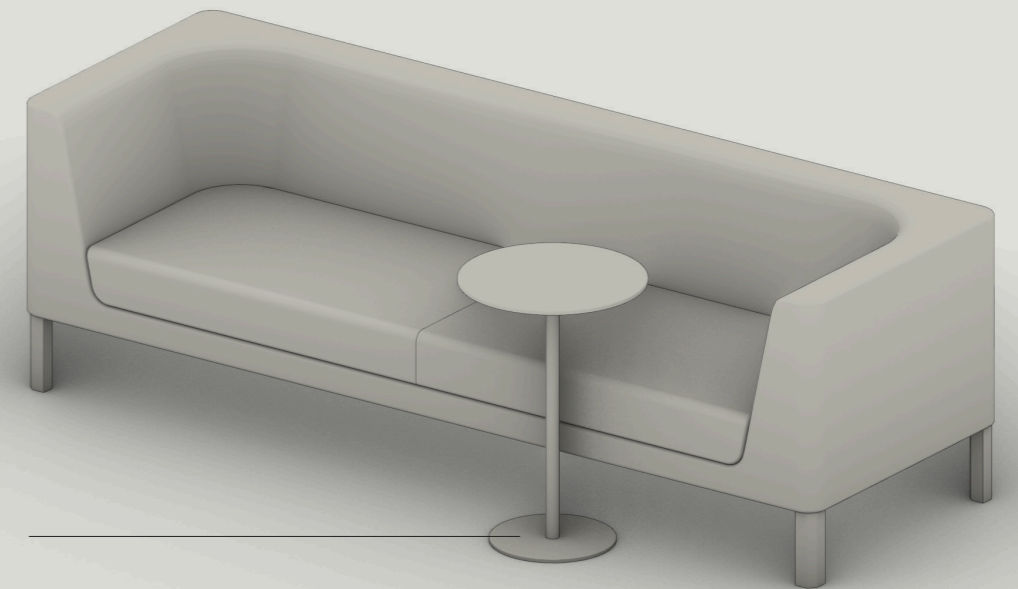

### 01 / UNIVERSAL TABLE AT-450

UNIVERSAL TABLES CAN BE ADDED TO LOUNGE CONFIGURATIONS TO PROVIDE A SURFACE FOR LAPTOP USE AND NOTE-TAKING.

# SPECIFICATIONS <sup>04</sup>

## OTTOMAN

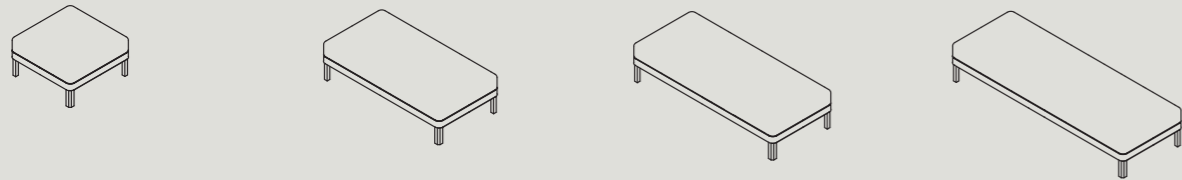

TO1  
W 770 D 770 H 400  
W 30.3" D 30.3" H 15.7"

TO2  
W 1500 D 770 H 400  
W 59.1" D 30.3" H 15.7"

TO3  
W 1800 D 770 H 400  
W 70.9" D 30.3" H 15.7"

TO4  
W 2100 D 770 H 400  
W 82.7" D 30.3" H 15.7"

## BACK ONLY LOUNGE

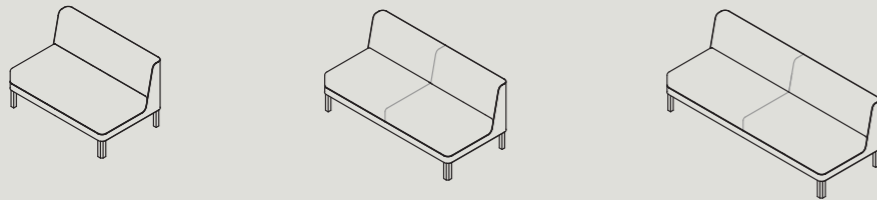

TB1  
W 1200 D 770 H 725 S 400  
W 47.2" D 30.3" H 28.5" S 15.7"

TB2  
W 1600 D 770 H 725 S 400  
W 63.0" D 30.3" H 28.5" S 15.7"

TB3  
W 2000 D 770 H 725 S 400  
W 78.7" D 30.3" H 28.5" S 15.7"

## SINGLE ARM LOUNGE

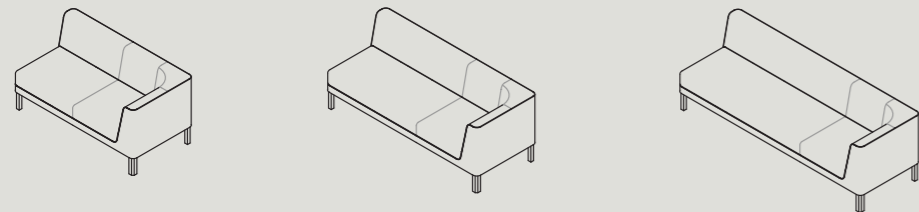

TA1 - R/L\*  
W 1530 D 770 H 725 S 400  
W 60.2" D 30.3" H 28.5" S 15.7"

TA2 - R/L\*  
W 1930 D 770 H 725 S 400  
W 75.0" D 30.3" H 28.5" S 15.7"

TA3 - R/L\*  
W 2330 D 770 H 725 S 400  
W 91.7" D 30.3" H 28.5" S 15.7"

\*R or L refers to Right or Left arm location. Arm location is defined while sitting on lounge.  
Dimensions shown are indicative. For projects requiring specific dimensions, please get in contact.

## LOUNGE

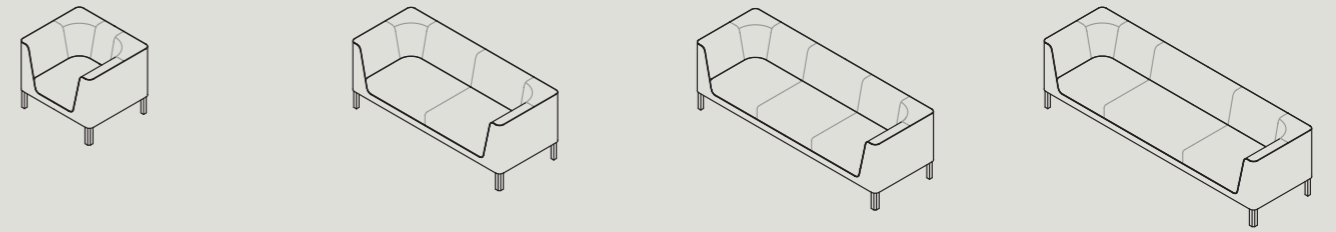

TL1  
W 950 D 770 H 725 S 400  
W 37.4" D 30.3" H 28.5" S 15.7"

TL2  
W 1900 D 770 H 725 S 400  
W 74.8" D 30.3" H 28.5" S 15.7"

TL3  
W 2300 D 770 H 725 S 400  
W 90.6" D 30.3" H 28.5" S 15.7"

TL4  
W 2700 D 770 H 725 S 400  
W 106.3" D 30.3" H 28.5" S 15.7"

## CURVED LOUNGE



TB60  
W 1595 D 1300 H 725 IR 1000 S 400  
W 62.8" D 51.2" H 28.5" IR 39.4" S 15.7"

TB90  
W 1575 D 1575 H 725 IR 750 S 400  
W 62.0" D 62.0" H 28.5" IR 29.5" S 15.7"

## BACK ONLY HIGH-BACK LOUNGE

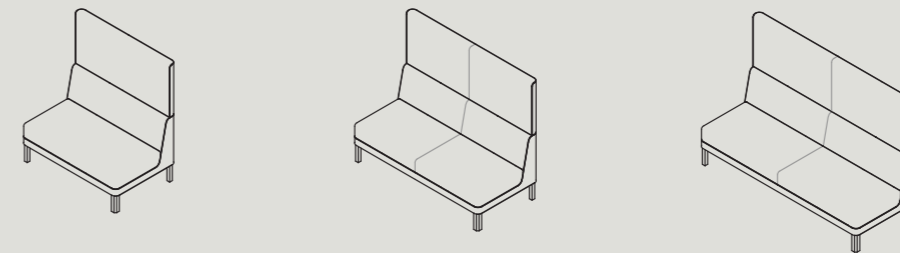

THBB1  
W 1200 D 770 H 1300 S 400  
W 47.2" D 30.3" H 51.2" S 15.7"

THBB2  
W 1600 D 770 H 1300 S 400  
W 63.0" D 30.3" H 51.2" S 15.7"

THBB3  
W 2000 D 770 H 1300 S 400  
W 78.7" D 30.3" H 51.2" S 15.7"

## SINGLE ARM HIGH-BACK LOUNGE



THBA1 - R/L\*  
W 1530 D 770 H 1300 S 400  
W 60.2" D 30.3" H 51.2" S 15.7"

THBA2 - R/L\*  
W 1930 D 770 H 1300 S 400  
W 75.0" D 30.3" H 51.2" S 15.7"

THBA3 - R/L\*  
W 2330 D 770 H 1300 S 400  
W 91.7" D 30.3" H 51.2" S 15.7"

HIGH-BACK LOUNGE



THBL1  
W 950 D 770 H 1300 S400  
W 37.4" D 30.3" H51.2" S 15.7"

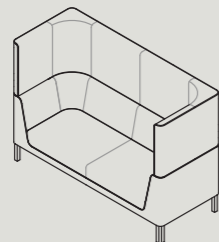

THBL2  
W 1900 D 770 H 1300 S400  
W74.8" D 30.3" H51.2" S 15.7"

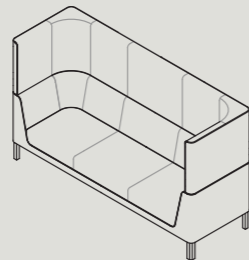

THBL3  
W 2300 D 770 H 1300 S400  
W 90.6" D 30.3" H51.2" S 15.7"

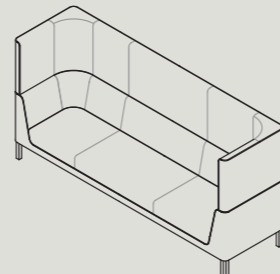

THBL4  
W 2700 D 770 H 1300 S400  
W 106.3" D 30.3" H51.2" S 15.7"

CURVED HIGH-BACK LOUNGE

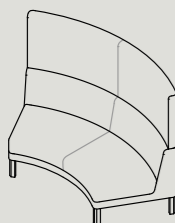

THBB60  
W 1595 D 1300 H 1300 IR 1000 S400  
W 62.8" D 51.2" H51.2" IR 39.4" S 15.7"

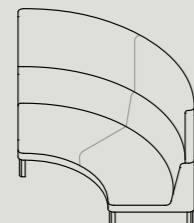

THBB90  
W 1575 D 1575 H 1300 IR 750 S400  
W 62.0" D 62.0" H51.2" IR 29.5" S 15.7"

HIGH-BACK BOOTH

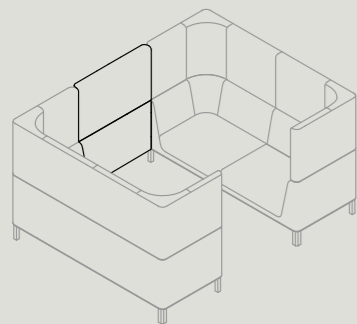

THBS900  
W 900  
W 35.4"

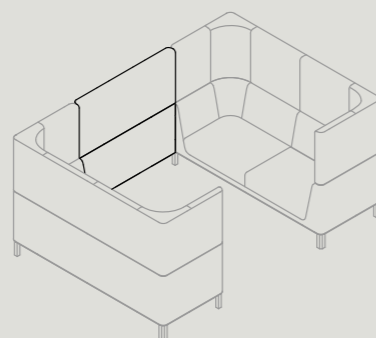

THBS1200  
W 1200  
W 47.2"

Dimensions shown are indicative. For projects requiring specific dimensions, please get in contact.

TABLE



AT-450  
W 450 D 450 H 650  
Ø17.7" H26.2"

TECHNICAL 05

AVAILABLE FINISHES

LOUNGE



CUSTOM FABRIC  
UPHOLSTERY



CUSTOM LEATHER  
UPHOLSTERY



NATURAL OAK  
LEGS



BLACK OAK  
LEGS

UNIVERSAL TABLE



BLACK POWDER COATED MDF  
TOP



BLACK POWDER COATED STEEL  
BASE

MATERIALS & POWER

LOUNGE

**INTERNAL FRAME** / The internal frame is constructed from plywood, kiln dried hardwood and steelwork. The seat utilises webbing for support, creating a high level of comfort and ensuring long-term endurance.

**BACK & ARM** / The back and arms are constructed from MDF, plywood, polyurethane foam and polyester batting.

**SEAT CUSHION AND UPHOLSTERY** / Formed from shaped polyurethane foam of different densities and polyethylene terephthalate to create a supportive yet comfortable seat. Overlaid with polyester batting for additional comfort. Upholstery and leathers are available in a range of varying textures, durability and tactility properties. Upholstery is selected at the time of ordering.

UNIVERSAL TABLE

**TABLE TOP** / Available in black powder coated MDF.

**TABLE BASE** / Constructed from tubular powder coated steel and powder coated sheet with a felt bottom (Universal Table).

POWER INTEGRATION

A power / USB module can be located to the underside of any module.

ENVIRONMENTAL

Tailored Lounges are made in Melbourne and fully GECA certified - FFG-200026. Under GECA, products are certified against environmental performance criteria across its life cycle to ensure they deliver better environmental outcomes.



## ROSS GARDAM

PHOTOGRAPHY BY HAYDN CATTACH - HAYDNCATTACH.COM

COLOUR AND SWATCHES SHOWN IN THIS DOCUMENT ARE FOR REFERENCE ONLY AND MAY DIFFER IN ACTUALITY.  
COPYRIGHT ©2020 ROSS GARDAM PTY LTD. ALL CONCEPTS, PHOTOGRAPHY AND IDEAS CONTAINED WITHIN THIS DOCUMENT  
ARE PRIVATE AND CONFIDENTIAL. THEY MUST NOT BE REPRODUCED IN ANY WAY OR FORM AND REMAIN THE INTELLECTUAL  
PROPERTY OF ROSS GARDAM. ALL PRODUCTS ARE REGISTERED DESIGNS WITH IP AUSTRALIA.